

Voltage Controlled Crystal Oscillators



GTQF
CMOS waveform

GPQF
PECL Differential

GDQF
LVDS Differential

2.5 V 3.3 V

Min.
10 MHz

Max.
1,500 MHz

Features

Quick - turn Clock Oscillators

1.2 pS Phase Jitter (typical)

The GTQF, GPQF and GDQF Series are members of Mercury's Q-Family Quick-Turn crystal oscillators that can be delivered within days. With low current consumption (54 mA for PECL 622.080 MHz at 3.3V) and an integrated phase jitter performance of 1.0 pS RMS, they have gained its precision frequency control market position by providing engineers with next-day samples for prototypes and low cost, fast delivery for volume production. The perfect solution to replace traditional XO's & VCXO's that use a more expensive, high-frequency, fundamental crystal and a noisy PLL multiplier circuit

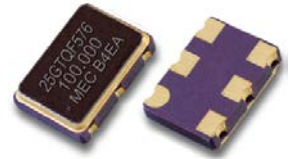

General specifications , at Ta=+25°C , CL=15pF

Model	GTQF		GPQF			GDQF				
Output Logic	CMOS		PECL			LVDS				
Supply Voltage V _{DD} (code)	+ 2.5 V _{DD} ± 5% (voltage code " 25 ") + 3.3 V _{DD} ± 5% (voltage code " 3 ")		+ 2.5 V _{DD} ± 5% (voltage code " 25 ") + 3.3 V _{DD} ± 5% (voltage code " 3 ")			+ 2.5 V _{DD} ± 5% (voltage code " 25 ") + 3.3 V _{DD} ± 5% (voltage code " 3 ")				
Available Frequency Range	10 ~ 250 MHz		10 ~ 1,500 MHz			10 ~ 1,500 MHz				
Load	15 pF		Differential			Differential				
Output Logic " High " , " 1 "	90 % V _{DD}		V _{DD} - 1.03 (min.) , V _{DD} - 0.6 (max.)			1.4 V Typical , 1.6 V max.				
Output Logic " Low " , " 0 "	10 % V _{DD}		V _{DD} - 1.85 (min.) , V _{DD} - 1.6 (max.)			1.1 V Typical , 0.9 V min.				
Current with Output Disable	16 mA typical		16 mA typical			16 mA typical				
Current Consumption (V _{DD} = + 3.3V)	10 MHz : 17 mA ; 150 MHz : 28 mA		100 MHz : 50 mA ; 750 MHz : 64 mA			100 MHz : 25 mA ; 750 MHz : 39 mA				
All values are typical and over the operating temperatures.	50 MHz : 20 mA ; 200 MHz : 33 mA		250 MHz : 55 Ma ; 1,000 : 68 mA			250 MHz : 30 mA ; 1,000 : 43 mA				
	100 MHz : 24 mA ; 250 MHz : 37 mA		500 MHz : 60 mA ; 1,350 MHz : 72 mA			500 MHz : 35 mA ; 1,350 MHz : 47mA				
Rise Time / Fall Time	1.5 nS. (Typical) , 3.0 nS. (max.) Tr / Tf : 10% ↔ 90% waveform		0.2 nS. (Typical) , 0.5 nS. (max.) Tr / Tf : 20% ↔ 80% waveform			0.2 nS. (Typical) , 0.4 nS. (max.) Tr / Tf : 20% ↔ 80% waveform				
Duty Cycle	50 % ± 5%									
Start-up Time	10 m sec. (max.)									
Aging at Ta = +25°C	± 2 ppm max. first year at 25°C ; ± 10 ppm max. over 10 years									
Storage Temperature	-55°C to + 150°C									
Frequency Stability (1) Codes	Frequency Stability over Operating Temperature Range		± 25 ppm	± 50 ppm	± 100 ppm	If non-standard , please enter the desired stability after the " C " or " I " represents . For example : " C20 " ± 20 ppm over -10°C to +70°C ; " I20 " ± 20 ppm over -40°C to +85°C				
	Commercial (-10°C to +70°C)		A	B	C					
	Industrial (-40°C to +85°C)		D	E	E					
SSB Phase Noise	Offset / Freq.	77.76 MHz	122.88 MHz	125 MHz	156.25 MHz	212.5 MHz	491.52 MHz	622.08 MHz	1,000 MHz	1,250 MHz
	10 Hz	-57	-68	-63	-55	-62	-61	-48	-52	-42
	100 Hz	-94	-99	-94	-85	-93	-86	-85	-82	-81
	1 KHz	-114	-113	-113	-109	-105	-100	-101	-93	-93
[dBc / Hz (typical)]	10 KHz	-123	-119	-118	-113	-113	-105	-102	-97	-96
	100 KHz	-124	-120	-119	-118	-115	-105	-103	-97	-97
	1 MHz	-144	-140	-137	-139	-135	-126	-124	-118	-119
		-152	-148	-148	-146	-143	-137	-133	-127	-129
Phase Jitter (12KHz ~ 20 MHz, RMS) unit : pS.	0.9		0.8	1.1	0.9	1.0	-1.1	1.2	1.5	1.1
Supply Voltage (V _{DD})	V _{DD} = +2.5 V ; Vcon Center = +1.25V					V _{DD} = +3.3 V ; Vcon Center = +1.65V				
Vcontrol Range	+ 0.2V ~ +2.3V ± 80 ppm (min.)					+ 0.3V ~ +3.0V ± 80 ppm (min.)				
Frequency Pulling Range	Up to ± 200 ppm (min.) is also available. Please contact Mercury.									
Absolute Voltage	2.8 V max. for 2.5V V _{DD} ; 4.0 V max. for 3.3V V _{DD}									
Linearity	± 5% typical. ±10% (max.)					Input Impedance 1 MΩ typical				
Transfer Function	Positive Transfer					Bandwidth 10 KHz min. Measured at -3 dB				
Output Enable Function										
OE Control on Pad 2	70% of V _{DD} (min.) to enable output. (Open connection prohibit.) 30% of V _{DD} (max.) to disable output .									
Output Enable Time / Disable Time	200 nS. Max. / 50 nS. Max.									
Integrated Phase Jitter	1.2 pS typical (12 KHz to 20 MHz) ; < 100 fS (1.875 KHz to 20 MHz)									

Outline Dimensions (Unit : mm) , Suggested pad Layout for SMDs

G_QF326	G_QF536	G_QF576
Pad Connections		
Pad 1 : Control Voltage ; Pad 2 : OE: High Enable ; Pad 3 : Ground ; Pad 4 : [CMOS : Output , PECL or LVDS : Differential] ;		
Pad 5 : [CMOS : NC , PECL or LVDS : Complementary] ; Pad 6 : Supply Voltage		

Mercury www.mercury-crystal.com

■Taiwan : Tel: (886)-2-2406-2779 / sales-tw@mercury-crystal.com

■USA : Tel: (1)-909-466-0427 / sales-us@mercury-crystal.com

■China : Tel: (86)-512-5763-8100 / sales-cn@mercury-crystal.com

Voltage Controlled Crystal Oscillators



GTQF
CMOS waveform

GPQF
PECL Differential

GDQF
LVDS Differential

2.5 V

3.3 V

Min.
10 MHz

Max.
1,500 MHz

Part Number Format and Example

Example : 3GPQN576 - E - 100N - 622.080

3	GPQF	576	-	E	-	100N	-	622.08
Supply Voltage	GTQF : CMOS "3" for 3.3V "25" for 2.5V	Package Size "576" : 7 x 5 mm "536" : 5 x 3.2 mm "326" : 3.2 x 2.5 mm		Frequency Stability Code "E": ± 50 ppm over -40 to +85°C. Other frequency stabilities are available.		± 100 ppm (min.) frequency pulling range.		Frequency (MHz)

Test Circuits and Output Waveforms

CMOS Test Circuit	PECL Test Circuit	LVDS Test Circuit
	<p>$V_{DD} = 3.3V$; $R1 = R3 = 127 \Omega$; $R2 = R4 = 82.5 \Omega$ $V_{DD} = 2.5V$; $R1 = R3 = 250 \Omega$; $R2 = R4 = 62.5 \Omega$</p>	
CMOS Output Wave Form	PECL Output Wave Form	LVDS Output Wave Form

Emboss Taping and Reel Specifications

[VCXO]

[(VC)TCXO]

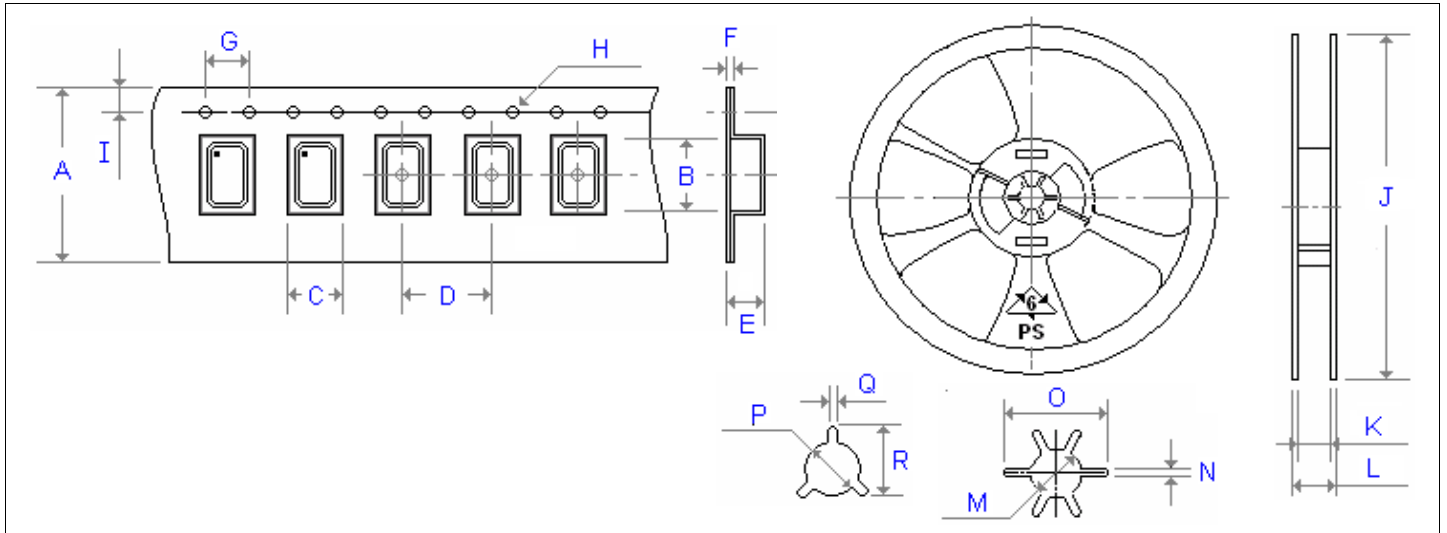

Carrier Type Dimensions (unit : mm)

	A	B	C	D	E	F	G	H	I	pcs / reel
G_324 (6)	8.0	3.4	2.7	4.0	1.4	0.3	4.0	∅ 1.50	1.75	3000
G_534	12.0	5.3	3.6	8.0	1.4	0.3	4.0	∅ 1.55	1.75	1000
G_576	16.0	7.3	5.3	8.0	1.9	0.3	4.0	∅ 1.55	1.75	1000
G_42	24.0	12.4	10.3	16.0	5.0	0.3	4.0	∅ 1.55	1.75	500
G_43	24.0	12.4	10.3	16.0	5.0	0.3	4.0	∅ 1.55	1.75	500
G_62	24.0	12.4	10.3	16.0	5.0	0.3	4.0	∅ 1.55	1.75	500
G_63	24.0	12.4	10.3	16.0	5.0	0.3	4.0	∅ 1.55	1.75	500
(V)M_22	8.0	2.8	2.3	4.0	1.1	0.3	4.0	∅ 1.50	1.75	3000
(V)M_32	8.0	3.4	2.7	4.0	1.4	0.3	4.0	∅ 1.50	1.75	3000
(V)MQ_326	12.0	3.6	2.9	4.0	1.7	0.3	4.0	∅ 1.55	1.75	3000
(V)M_53	12.0	5.3	3.6	8.0	1.4	0.3	4.0	∅ 1.55	1.75	1000
(V)M_57	16.0	7.4	5.5	8.0	2.8	0.4	4.0	∅ 1.50	1.75	500
(V)M_42	24.0	12.4	10.3	16.0	5.0	0.3	4.0	∅ 1.55	1.75	500
(V)M_43	24.0	12.4	10.3	16.0	5.0	0.3	4.0	∅ 1.55	1.75	500
(V)M_62	24.0	12.4	10.3	16.0	5.0	0.3	4.0	∅ 1.55	1.75	500
(V)M_63	24.0	12.4	10.3	16.0	5.0	0.3	4.0	∅ 1.55	1.75	500

Reel Dimensions (unit : mm)

	J	K	L	P	Q	R	pcs / reel
G_324 (6)	180.0	9.0	12.0	13.2	2.1	-	3000
G_534	180.0	13.0	16.0	13.2	2.5	-	1000
G_576	180.0	17.2	19.3	13.3	2.2	22.0	1000
G_42	330.0	30.0	25.0	13.4	2.5	19.5	500
G_43	330.0	30.0	25.0	13.4	2.5	19.5	500
G_62	330.0	30.0	25.0	13.4	2.5	19.5	500
G_63	330.0	30.0	25.0	13.4	2.5	19.5	500
(V)M_22	180.0	9.0	12.0	13.2	2.1	-	3000
(V)M_32	180.0	9.0	12.0	13.2	2.1	-	3000
(V)MQ_326	180.0	9.0	12.0	13.2	2.1	-	3000
(V)M_53	180.0	13.0	16.0	13.2	2.5	19.5	1000
(V)M_57	180.0	17.2	19.3	13.3	2.2	22.0	500
(V)M_42	330.0	30.0	25.0	13.4	2.5	19.5	500
(V)M_43	330.0	30.0	25.0	13.4	2.5	19.5	500
(V)M_62	330.0	30.0	25.0	13.4	2.5	19.5	500
(V)M_63	330.0	30.0	25.0	13.4	2.5	19.5	500