

High Frequency Ultra-low Jitter Voltage Controlled Crystal Oscillators [ Quick - turn VCXO , 15 ~ 2,100 MHz ]

**G\_JF**

CMOS / Differential

**150 fsec typical Phase Jitter**

**SMD**

**1.8 V**

**2.5 V**

**3.3 V**

Min.

**15 MHz**

Max.

**2,100 MHz**

Features

G\_JF series (8 pads), a member of Mercury QuikXO™ quick-turn Voltage Controlled Crystal Oscillators VCXOs, features CMOS, LVPECL, LVDS, CML or HCSL output logics and Ultra-low RMS phase jitter (163 fsec for 250 MHz at 3.3V, 12 KHz to 20 MHz). Operating voltages are 1.8V, 2.5V or 3.3V. Applications include, networking, wireless infrastructure, high resolution audio and video, high-speed data converters and storage area networks.

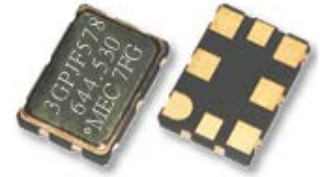

General specifications , at Ta=+25°C

Model	GTJF	GPJF	GDJF	GCJF	GQJF
<b>Output Logic</b>	<b>CMOS</b>	<b>PECL</b>	<b>LVDS</b>	<b>HCSL</b>	<b>CML</b>
Supply Voltage	+ 1.8 V <sub>DD</sub> ± 5%	---	+ 1.8 V <sub>DD</sub> ± 5% (*)	+ 1.8 V <sub>DD</sub> ± 5%	+ 1.8 V <sub>DD</sub> ± 5%
	+ 2.5 V <sub>DD</sub> ± 10%	+ 2.5 V <sub>DD</sub> ± 10%	+ 2.5 V <sub>DD</sub> ± 10%	+ 2.5 V <sub>DD</sub> ± 10%	+ 2.5 V <sub>DD</sub> ± 10%
	+ 3.3 V <sub>DD</sub> ± 10%	+ 3.3 V <sub>DD</sub> ± 10%	+ 3.3 V <sub>DD</sub> ± 10%	+ 3.3 V <sub>DD</sub> ± 10%	+ 3.3 V <sub>DD</sub> ± 10%
Available Frequency Range	15 ~ 250 MHz	15 ~ 2,100 MHz	15 ~ 2,100 MHz	15 ~ 700 MHz	15 ~ 2,100 MHz
Load	15pF max.	50 Ω into V <sub>DD</sub> - 2V or Thevenin equivalent	100 Ω between OUT and OUTN	50 Ω to GND	50 Ω to V <sub>DD</sub>
Output Logic " High " , " 1 "	V <sub>DD</sub> - 0.4V min.	V <sub>DD</sub> - 1.165 V min. V <sub>DD</sub> - 0.8 V max.	V <sub>DD</sub> : 1.4V typical V <sub>DD</sub> : 1.6 V max.	V <sub>DD</sub> : 0.66V min V <sub>DD</sub> : 1.15 V max.	V <sub>DD</sub> - 0.085V min. V <sub>DD</sub> = max.
Output Logic " Low " , " 0 "	V <sub>DD</sub> × 0.1 max. 0.3V max. for 1.8V only	V <sub>DD</sub> - 2.0 V min. V <sub>DD</sub> - 1.55 V max.	V <sub>DD</sub> : 1.1 V typical V <sub>DD</sub> : 0.9 V min.	V <sub>DD</sub> : 0.0V min. V <sub>DD</sub> : 0.15V max.	V <sub>DD</sub> - 0.6V min. V <sub>DD</sub> - 0.32V max.
Output Voltage Swing	---	595 mV min. 930 mV max.	250 mV min. 450 mV max.	620 mV min. 780 mV max.	200 mV min. 600 mV typ.
Current Consumption ( V <sub>DD</sub> = + 3.3 V )	50MHz : 70 mA typ. 250MHz : 80 mA typ.	100 mA typ. 120 mA max.	75 mA typ. 90 mA max.	80 mA typ. 100 mA max.	70 mA typ. 85 mA max.
Current with Output Disabled	63 mA typical	99 mA typical	74 mA typical	79 mA typical	69 mA typical
Rise Time / Fall Time	5.0 nS max. ( 10% to 90% Waveform )	0.4 nS max. ( 20% to 80% Waveform )	0.4 nS max. ( 20% to 80% Waveform )	0.4 nS max. ( 20% to 80% Waveform )	0.4 nS max. ( 20% to 80% Waveform )
RMS Phase Jitter ( typical ) ( 12 KHz to 20 MHz )	156.250 MHz : 159 fs ; 491.520 MHz : 155 fs ; 644.530 MHz : 151 fs ; 1,480 MHz : 147 fs ; 2,000 MHz : 163 fs				
Frequency Stability Codes	Frequency Stability Over Operating Temperature Range	± 25 ppm	± 50 ppm	± 100 ppm	If non-standard , please enter the desired stability after the " C " or " I " represents . For example : " C20 " ± 20 ppm over -10°C to +70°C ; " I40 " ± 40 ppm over -40°C to +85°C
	Commercial ( -10°C to +70°C )	A	B	C	
	Industrial ( -40°C to +85°C )	D	E	F	
Duty Cycle	50 % ± 5% ; 50 % ± 10% for CMOS 1.8V only				
Start-up Time	5 m sec typical ; 10 m sec. max.				
Aging at Ta = +25°C	± 3 ppm max. for first year at 25°C ; ± 2 ppm max. per year thereafter				
Storage Temperature	-55°C to + 150°C				
<b>Control Voltage Function on Pad 1</b>					
Vcontrol Center	+ 0.9 V for V <sub>DD</sub> = + 1.8 V	+ 1.25 V for V <sub>DD</sub> = + 2.5 V		+ 1.65 V for V <sub>DD</sub> = + 3.3 V	
Vcontrol Range	+ 0.0V ~ +1.8V	+ 0.25V ~ +2.25V		+ 0.3V ~ +3.0V	
Frequency Pulling Range	± 100 ppm min. ± 200 ppm ( available )	± 100 ppm min. ± 200 ppm ( available )		± 100 ppm min. ± 200 ppm ( available )	
Linearity	± 1% typical ; ±10% max.				
Transfer Function	Positive Transfer				
Input Impedance	5 MΩ min.				
Bandwidth	10 KHz typ. Measured at -3 dB				
<b>Output Enable Function on Pad 2</b>					
Output Enable / Disable Function	80% of V <sub>DD</sub> ( min.) to enable output.				
	20% of V <sub>DD</sub> ( max.) to disable output.				
Output Enable Time / Disable Time	2.5 ms max. / 10 us max.				

Mercury [www.mercury-crystal.com](http://www.mercury-crystal.com) ■ Taiwan : Tel: (+886)-2-2406-2779 / sales-tw@mercury-crystal.com

■ USA : Tel: (+1)-909-466-0427 / sales-us@mercury-crystal.com ■ China : Tel: (+86)-512-5763-8100 / sales-cn@mercury-crystal.com

High Frequency Ultra-low Jitter Voltage Controlled Crystal Oscillators [ Quick - turn VCXO , 15 ~ 2,100 MHz ]

**G\_JF**

CMOS / Differential

**150 fsec typical Phase Jitter**

**SMD**

**1.8 V**

**2.5 V**

**3.3 V**

Min.

15 MHz

Max.

2,100 MHz

Part Number Format and Example

Example : 3GPJF578-E-150N-644.530

3	G	P	JF578	-	E	-	150N	-	644.530
Supply Voltage Code : "3" for 3.3V "25" for 2.5V "18" for 1.8V	"G" : for Voltage Controlled Crystal Oscillators	Output Code : "T" : COMS "P" : PECL "D" : LVDS "C" : HCSL "Q" : CML	"JF" : Product Series "578" : Package Code 7.0 x 5.0 _ 8 Pad "538" : Package Code 5.0 x 3.2 _ 8 Pad	-	Freq. Stability Code : "E" : ±50 ppm over -40 to +85 C Other frequency stabilities are available.	-	Freq. Pulling Range : "150" : ±150ppm "M" : Maximum "N" : Minimum "T" : Typical	-	Frequency (MHz)

Outline Dimensions ( Unit : mm ) , Suggested pad Layout for SMDs

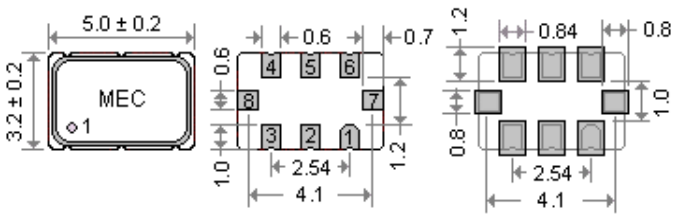
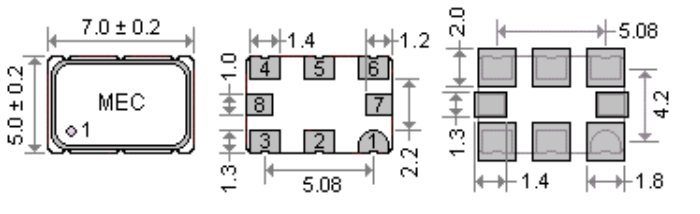
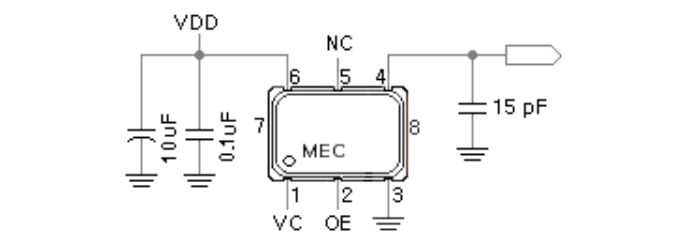
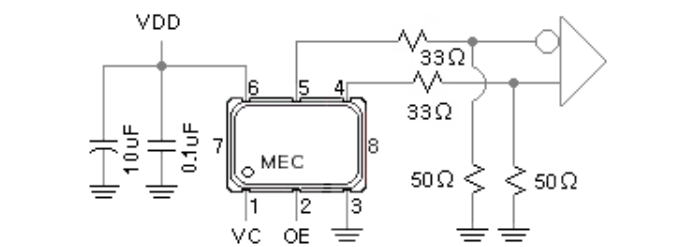
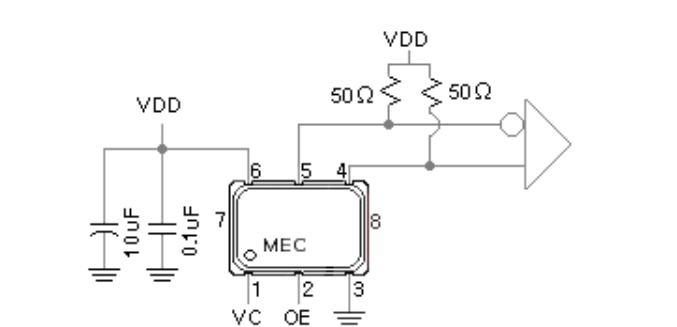
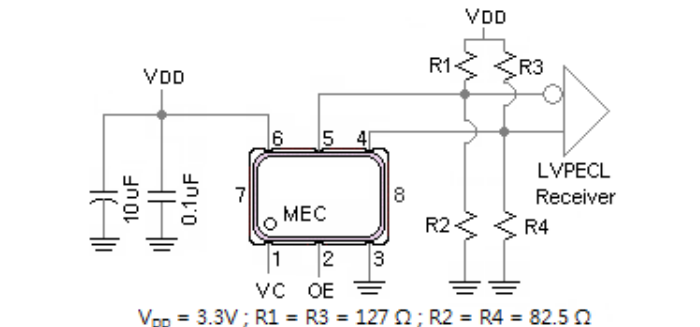
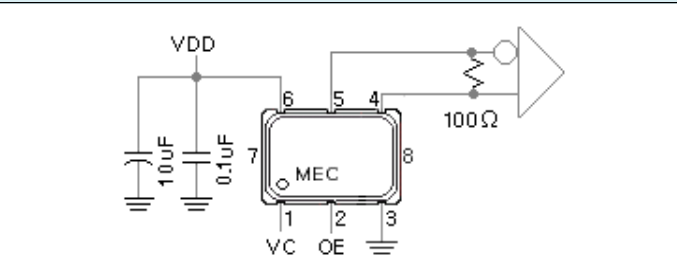
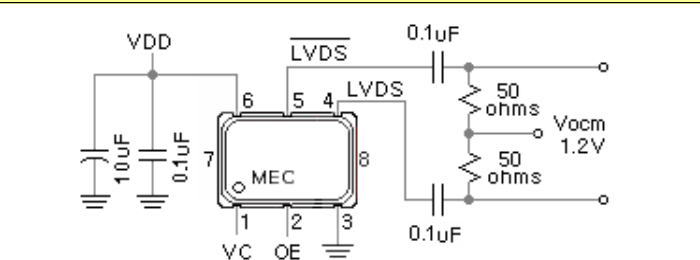
G_JF538	G_JF578
 <p>Pad 1 : VC Pad 2 : OE Pad 3 : Ground Pad 4 : Output Pad 5 : Complementary Output Pad 6 : Supply Voltage Pad 7 : Do not connect Pad 8 : Do not connect</p>	 <p>Pad 1 : VC Pad 2 : OE Pad 3 : Ground Pad 4 : Output Pad 5 : Complementary Output Pad 6 : Supply Voltage Pad 7 : Do not connect Pad 8 : Do not connect</p>
CMOS Test Circuits	HCSL Test Circuits
	
CML Test Circuits	LVPECL Test Circuits
	 <p>V<sub>DD</sub> = 3.3V; R<sub>1</sub> = R<sub>3</sub> = 127 Ω; R<sub>2</sub> = R<sub>4</sub> = 82.5 Ω V<sub>DD</sub> = 2.5V; R<sub>1</sub> = R<sub>3</sub> = 250 Ω; R<sub>2</sub> = R<sub>4</sub> = 62.5 Ω</p>
LVDS Test Circuits for 2.5V and 3.3V	LVDS Test Circuits for 1.8V only (*)
	

# Emboss Taping and Reel Specifications

[ VCXO ]

[ ( VC )TCXO ]

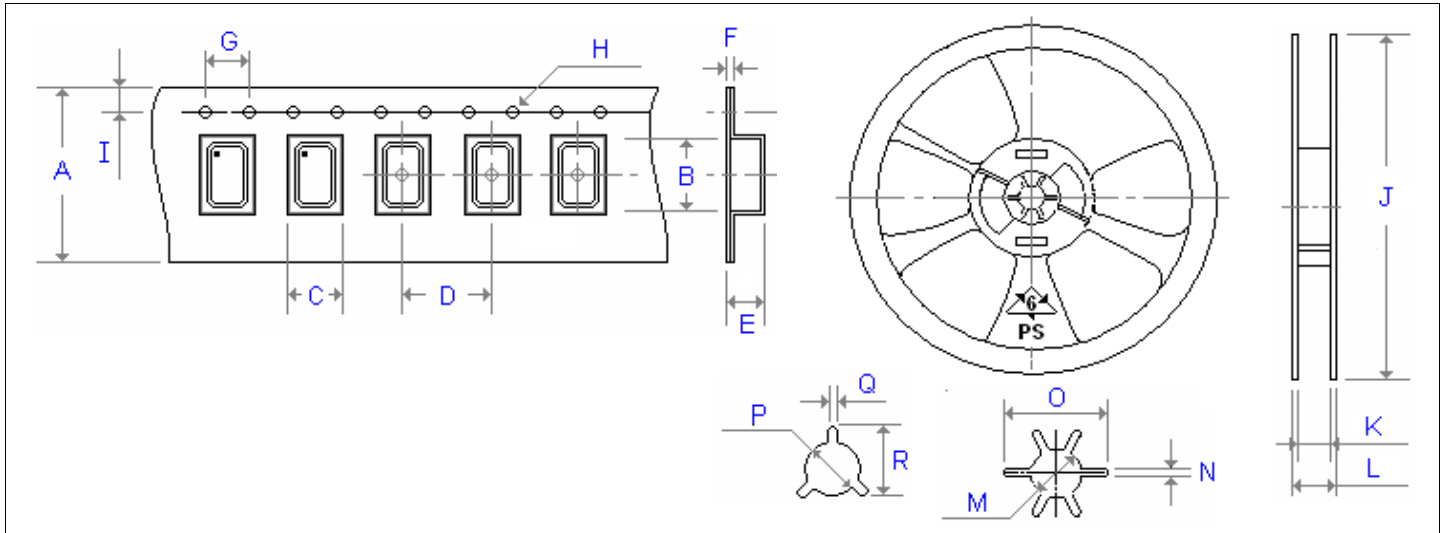

Carrier Type Dimensions ( unit : mm )

	A	B	C	D	E	F	G	H	I	pcs / reel
G_324 ( 6 )	8.0	3.4	2.7	4.0	1.4	0.3	4.0	∅ 1.50	1.75	3000
G_534	12.0	5.3	3.6	8.0	1.4	0.3	4.0	∅ 1.55	1.75	1000
G_576	16.0	7.3	5.3	8.0	1.9	0.3	4.0	∅ 1.55	1.75	1000
G_42	24.0	12.4	10.3	16.0	5.0	0.3	4.0	∅ 1.55	1.75	500
G_43	24.0	12.4	10.3	16.0	5.0	0.3	4.0	∅ 1.55	1.75	500
G_62	24.0	12.4	10.3	16.0	5.0	0.3	4.0	∅ 1.55	1.75	500
G_63	24.0	12.4	10.3	16.0	5.0	0.3	4.0	∅ 1.55	1.75	500
(V)M_22	8.0	2.8	2.3	4.0	1.1	0.3	4.0	∅ 1.50	1.75	3000
(V)M_32	8.0	3.4	2.7	4.0	1.4	0.3	4.0	∅ 1.50	1.75	3000
(V)MQ_326	12.0	3.6	2.9	4.0	1.7	0.3	4.0	∅ 1.55	1.75	3000
(V)M_53	12.0	5.3	3.6	8.0	1.4	0.3	4.0	∅ 1.55	1.75	1000
(V)M_57	16.0	7.4	5.5	8.0	2.8	0.4	4.0	∅ 1.50	1.75	500
(V)M_42	24.0	12.4	10.3	16.0	5.0	0.3	4.0	∅ 1.55	1.75	500
(V)M_43	24.0	12.4	10.3	16.0	5.0	0.3	4.0	∅ 1.55	1.75	500
(V)M_62	24.0	12.4	10.3	16.0	5.0	0.3	4.0	∅ 1.55	1.75	500
(V)M_63	24.0	12.4	10.3	16.0	5.0	0.3	4.0	∅ 1.55	1.75	500

Reel Dimensions ( unit : mm )

	J	K	L	P	Q	R	pcs / reel
G_324 ( 6 )	180.0	9.0	12.0	13.2	2.1	-	3000
G_534	180.0	13.0	16.0	13.2	2.5	-	1000
G_576	180.0	17.2	19.3	13.3	2.2	22.0	1000
G_42	330.0	30.0	25.0	13.4	2.5	19.5	500
G_43	330.0	30.0	25.0	13.4	2.5	19.5	500
G_62	330.0	30.0	25.0	13.4	2.5	19.5	500
G_63	330.0	30.0	25.0	13.4	2.5	19.5	500
(V)M_22	180.0	9.0	12.0	13.2	2.1	-	3000
(V)M_32	180.0	9.0	12.0	13.2	2.1	-	3000
(V)MQ_326	180.0	9.0	12.0	13.2	2.1	-	3000
(V)M_53	180.0	13.0	16.0	13.2	2.5	19.5	1000
(V)M_57	180.0	17.2	19.3	13.3	2.2	22.0	500
(V)M_42	330.0	30.0	25.0	13.4	2.5	19.5	500
(V)M_43	330.0	30.0	25.0	13.4	2.5	19.5	500
(V)M_62	330.0	30.0	25.0	13.4	2.5	19.5	500
(V)M_63	330.0	30.0	25.0	13.4	2.5	19.5	500